



QwikCheck™ QC Equine User Guide

Catalog # QCh-A-00342-00

Version 1.00

June 2009



TABLE OF CONTENTS

Section 1: Overview	3
Section 2: System Overview	3
Section 3: Operating the QwikCheck™QCe	4
Section 4: Sample Testing	4
Extended	5
Cooled	6
Frozen	7
Section 5: Add I-button Tests	8
Section 6: Service Menu	8
Service Data	9
Default Settings	9
Service Personnel	9
Section 7: Troubleshooting	10
Appendix 1: Semen Sample Preparation	11
Appendix 2: Capillary Filling Instructions: EXTENDED and COOLED samples	12
Appendix 3: Capillary Filling Instructions: FROZEN samples	13
Appendix 4: Capillary Washing/Drying Instructions	14
Appendix 5: Cleaning the QwikCheck QCe Testing Chamber	16
Appendix 6: Glossary of Terms	17
Appendix 7: System Specifications	18

Section 1: Overview

The QwikCheck™QC Equine sperm quality analyzer is used to test and report the quality of EXTENDED,COOLED and FROZEN equine semen prior to insemination. The following semen parameters are reported:

Reported Semen Parameters	
CONC *	Millions / milliliter
MOTILITY	%
PROGRESSIVE MOTILITY	%
MSC	Millions / milliliter
PMSC	Millions / milliliter
VELOCITY	Microns/second

* Not in frozen samples

The QwikCheck™QCe:

- Quickly reports accurate and precise test results.
- Is fully automated and provides a 40 second analysis of horse semen using only 20µl of sample.
- Prints test results to an optional label printer to make it easy to track the quality of the tested samples.

Section 2: System Overview

QwikCheck™
QCe Equine

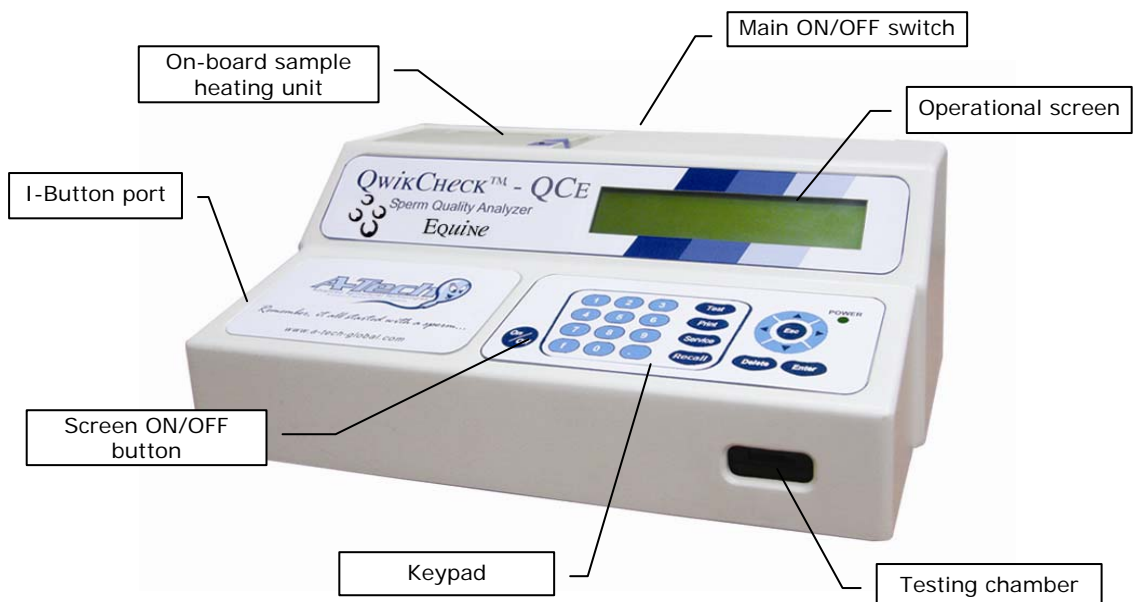

QwikCheck™
QCe Equine
sample heating
unit:

- On-board sample heating unit will pre-heat:
- 3 testing capillaries
 - 3 – 10ml sample containers

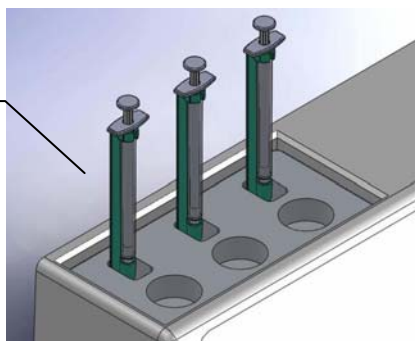

**QwikCheck™
QCe
Testing
Capillary**

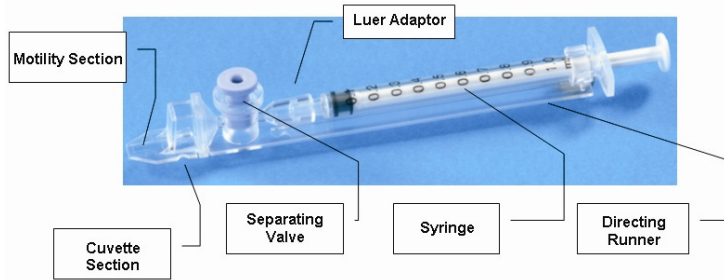

- Plastic, multi-use (animal only), disposable.
- Refer to the appendix section for filling, washing and drying instructions.

Section 3: Operating the QwikCheck™ QCe Equine

- Turn on the main switch on the rear panel
- Press the On/Off key on the QwikCheck™ QCe keypad.
- The system will now perform auto-calibration.
- Press the **ENTER** key to view the **MAIN MENU**.

Three options are available from the **MAIN MENU**:

- **TEST NEW SAMPLE**
- **ADD I-BUTTON TESTS**
- **SERVICE**

When using the system for the first time please:

- Load I-Button tests: Go to: **MAIN MENU > ADD I-BUTTON TESTS**
- Set-up the system defaults: Go to: **MAIN MENU > SERVICE > DEFAULT SETTINGS**

NOTE: Load I-button tests and set system defaults **PRIOR** to testing (see Section 6 **SERVICE** for full instructions)

Section 4: Sample Testing

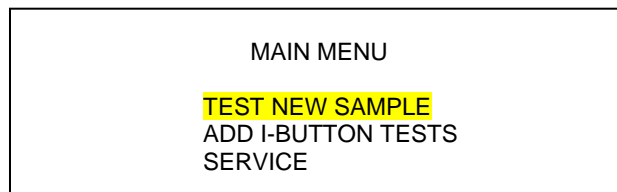

Select the first option from the **MAIN MENU** and the screen below will be displayed:

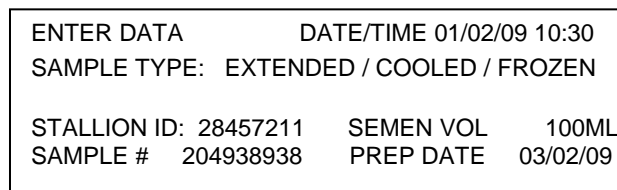

- Enter the following:
 - Stallion ID: up to 8 digits
 - Sample #: up to 10 digits
 - Semen Volume: up to 3 integers and 2 decimal points
 - Preparation Date: the date the semen was extended
- Press the ENTER button on the keypad. The system QCe will now auto-calibrate. **DO NOT** insert a testing capillary or touch the system at this time.
- A 'beep' will sound when the system is ready for testing.
- Follow the sample preparation and heating **on screen instructions**.
- Insert the testing capillary only when the beep sounds.

NOTE: Wait until the QwikCheck QCe beeps before inserting a testing capillary.

**SAMPLE TESTING:
EXTENDED**

NOTE:
EXTENDED samples are pre-heated for 4 minutes.

NOTE:
Do not insert the capillary until the screen instruction appears and a beep is heard.

If **EXTENDED** sample type was selected, the screen below will be displayed:

EXTENDED SPECIMEN AUTO CALIBRATION	PRE-HEAT 2 ml SAMPLE: 4 MIN PRE-HEAT EMPTY CAPILLARY: > 4 MIN MIX SAMPLE FILL AND WIPE CAPILLARY
------------------------------------	---

- Insert the testing capillary when instructed by the screen:

EXTENDED SPECIMEN INSERT INTO CHAMBER	PRE-HEAT 2 ml SAMPLE: 4 MIN PRE-HEAT EMPTY CAPILLARY: > 4 MIN MIX SAMPLE FILL AND WIPE CAPILLARY
---	---

- Testing will begin automatically and take approximately 45 seconds after an initial pre-heating of 2 minutes.

<p>DO NOT TOUCH THE CAPILLARY OR SYSTEM DURING TESTING</p> <p>WAIT FOR BEEP</p> 
--

- A "beep" will sound when the test is done. The screen below will be displayed:

ANALYSIS REPORT	DATE/TIME 04/02/09 10:30
SAMPLE TYPE: EXTENDED	
STALLION ID: 28457211	SEMEN VOL 100ML
SAMPLE # 204938938	PREP DATE 03/02/09

- Press ENTER to display the next screen seen below:

TEST RESULTS			
CONC	25.3 M/ml	MSC	19.2 M/ml
MOTILITY	75.8%	PMSC	15.9 M/ml
PROG. MOT.	62.7%	VELOCITY	58 Mic/sec

- To print a test results label – press the PRINT button on the keypad

PRINTING THE TEST RESULTS:

QwikCheck QC EQUINE	
DEVICE SN	382
SW VERSION	01.00.00
TEST DATE	01/02/09
TEST TIME	15:26
SAMPLE:	EXTENDED
STALLION#	128457211
SAMPLE#	204938938
SEMEN VOL	100.0 ml
PREP DATE	26/02/08
TEST RESULTS	
CONC	25.3 M/ml
MOTILITY	75.8 %
PR. MOT.	62.7 %
MSC	19.2 M/ml
PMSC	15.9 M/ml
VELOCITY	58 mic/sec

SAMPLE TESTING:
COOLED

If **COOLED** sample type was selected, the screen below will be displayed:

SAMPLE COOLED > = 24 HOURS YES/NO

- Select YES if the sample was cooled 24 hours or more before testing.

COOLED SPECIMEN AUTO CALIBRATION	PRE-HEAT 2 ml SAMPLE: 7 MIN PRE-HEAT EMPTY CAPILLARY: > 4 MIN MIX SAMPLE FILL AND WIPE CAPILLARY
----------------------------------	---

NOTE:
COOLED samples are pre-heated for 7 minutes.

- **Insert the testing capillary when instructed by the screen:**

COOLED SPECIMEN INSERT INTO CHAMBER	PRE-HEAT 2 ml SAMPLE: 7 MIN PRE-HEAT EMPTY CAPILLARY: > 4 MIN MIX SAMPLE FILL AND WIPE CAPILLARY
---	---

NOTE:
Do not insert the capillary until the screen instruction appears and a beep is heard.

- Testing will begin automatically after an initial 2 minute pre-heating phase.

DO NOT TOUCH THE CAPILLARY OR SYSTEM DURING TESTING
WAIT FOR BEEP

- A "beep" will sound when the test is done. The screen below will be seen:

ANALYSIS REPORT DATE/TIME 04/02/09 10:30
SAMPLE TYPE: COOLED

STALLION ID: 28457211 SEMEN VOL 100ML
SAMPLE # 204938938 PREP DATE 03/02/09

- Press ENTER to display the next screen seen below:

TEST RESULTS: COOLED SAMPLE

CONC	25.3 M/ml	MSC	17.4 M/ml
MOTILITY	60.8%	PMSC	12.9 M/ml
PROG. MOT.	42.7%	VELOCITY	41 Mic/sec

- To print a test results label – press the PRINT button on the keypad

PRINTING THE TEST RESULTS:

```

QwikCheck QC EQUINE
TEST RESULTS
DEVICE SN           382
SW VERSION          01.00.00
TEST DATE           01/02/09
TEST TIME           15:26
SAMPLE              COOLED
STALLION ID         335588211
SAMPLE #            350938938
SEMEN VOL           100.0 ml
PREP DATE           26/02/08
COOLED >= 24h      NO
TEST RESULTS
CONC                25.3 M/ml
MOTILITY            60.8 %
PROG MOT            42.7 %
MSC                 17.4 M/ml
PMSC                12.9 M/ml
VELOC               41 mic/sec
    
```

SAMPLE TESTING: FROZEN

NOTE:

FROZEN samples are pre-heated for 4 minutes.

NOTE:

The testing capillary is filled differently in the FROZEN mode so that a small sample can be run. Refer to the Appendix section for instructions.

NOTE:

Do not insert the capillary until the screen instruction appears and a beep is heard.

If **FROZEN** sample type was selected, the screen below will be displayed:

PRE-HEAT SAMPLE 4 MIN; CAPILLARY > 4 MIN
 MIX SAMPLE, FILL CAPILLARY 20 µl
 REMOVE BLUE VALVE, WIPE TIP
 <<AUTOCALIBRATION >>

- Insert the testing capillary when instructed by the screen:

PRE-HEAT SAMPLE 4 MIN; CAPILLARY > 4 MIN
 MIX SAMPLE, FILL CAPILLARY 20 µl
 REMOVE BLUE VALVE, WIPE TIP
 <<INSERT CAPILLARY INTO CHAMBER>>

- Testing will begin automatically after an initial 2 minute pre-heating.

DO NOT TOUCH THE CAPILLARY OR SYSTEM DURING TESTING
 <<WAIT FOR BEEP>>

- A "beep" will sound when the test is done. The screen below will be displayed:

ANALYSIS REPORT DATE/TIME 04/02/09 10:30
 SAMPLE TYPE: FROZEN

 STALLION ID: 28457211 SEMEN VOL 0.25 ML
 SAMPLE # 204938938 PREP DATE 03/02/09

- Press ENTER to display the next screen seen below:

TEST RESULTS

CONC	NA	MSC	19.2 M/ml
MOTILITY	35.8%	PMSC	15.9 M/ml
PROG. MOT.	45.7%	VELOCITY	40 Mic/sec

- To print a test results label – press the PRINT button on the keypad

QwikCheck QC EQUINE

DEVICE SN	382
SW VERSION	01.00.00
TEST DATE	01/02/09
TEST TIME	15:26
SAMPLE:	FROZEN
STALLION#	128457211
SAMPLE#	204938938
SEMEN VOL	0.25 ml
PREP DATE	26/02/08
TEST RESULTS	
MOTILITY	35.8 %
PR. MOT.	45.7 %
MSC	19.2 M/ml
PMSC	15.9 M/ml
VELOCITY	40 mic/sec

PRINTING THE TEST RESULTS:

SAMPLE TESTING: LOW MOTILITY

- If motility is <=30% only MSC and PMSC will be reported
- If motility is <10% a message will appear: SEMEN PARAMETERS CANNOT BE MEASURED – no results can be reported

I-BUTTON TESTS

Section 5: Add I-Button Tests

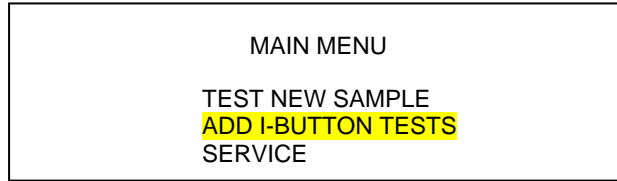

To load I-Button tests go to: **MAIN MENU > ADD I-BUTTON TESTS**, press **ENTER** The screen below will be displayed:

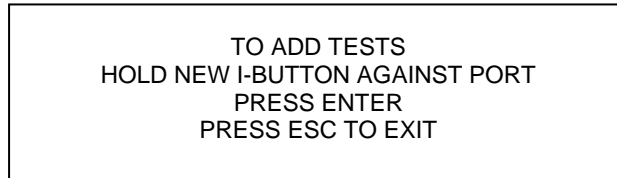

- Using a new I-Button from the test kit, follow the above instructions. **HOLD the I-Button against the port during the entire process:**

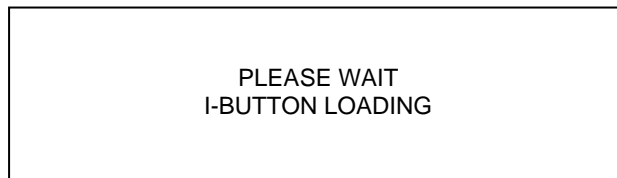

- The screen below will display the #tests added and the total remaining number of tests.

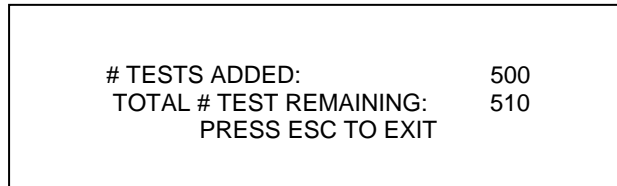

Section 6: Service

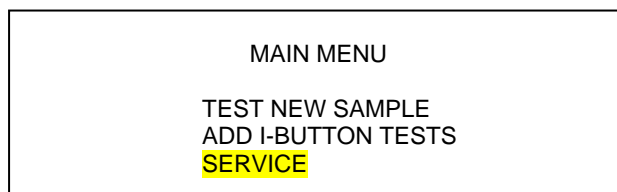

Select **SERVICE** from the **MAIN MENU** to enter service screens (move the cursor to this option and press ENTER). The screen below will be displayed:

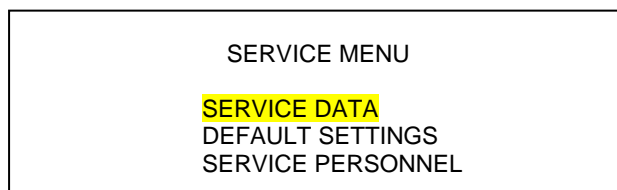

NOTE: If the I-Button is not properly inserted a message: **I-BUTTON NOT PROPERLY ACTIVATED** will be displayed. Remove the button, press ESC and try again.

Select **SERVICE DATA** to view the SERVICE DATA, SELF-TEST DATA and ALGORITHM screens displayed below. These screens contain information about the QwikCheck™QCe that is required for technical support.

SERVICE DATA					
18	28	0.000	6	87	107
5	68.0	112	89	100	2
150	512	10	31	1.3	
SELF-TEST DATA					
REF 1	240	REF2	2985		
LCUR1	12	LCUR2	20		
AMP	72	ZL	512		
ALGORITHM					
MSC	903.7	# SPIKES	61		
PMSC	123.2	# TESTS	XXX		
AW	15600	SW VER.	1.00.56		

NOTE: Contact local distributor for help.

DEFAULT SETTINGS

Select **DEFAULT SETTINGS** from the **SERVICE MENU** to set-up the QwikCheck™ for testing and printing results.

DEFAULT SETTINGS

SERVICE MENU SERVICE DATA DEFAULT SETTINGS SERVICE PERSONNEL
--

- Set the QwikCheck™QCe default parameters on the two screens displayed below by moving the cursor over the desired setting and pressing **ENTER**.
- **CONC STD:** Select "1" for Neubauer or "2" for Neucleocounter type

DEFAULT SETTINGS		
LOCAL TIME	08:15:45	HH:MM:SS 24 h
DATE FORMAT	MM/DD/YY	DD/MM/YY
SET DATE	04/01/08	

DEFAULT SETTINGS	
AUTOMATIC PRINTING	YES/NO
# OF LABELS TO PRINT	1 / 2
CONC. STD	1 / 2

SERVICE PERSONNEL:

This option requires a password and is for technical service personnel only.

SERVICE MENU SERVICE DATA DEFAULT SETTINGS SERVICE PERSONNEL
--

Section 7: Troubleshooting

Stabilization Failed:

STABILIZATION FAILED
TURN DEVICE OFF AND ON
IF SYSTEM FAILS AGAIN,
CALL TECHNICAL SUPPORT

Failed Self-test:

FAILED SELF-TEST
TURN OFF DEVICE
CLEAN TESTING CHAMBER
TURN DEVICE ON

1. Remove any testing capillary from the measurement compartment.
2. Remove the QwikCheck™QCe from all sources of electronic noise (centrifuge, cell phones, etc.).
3. Clean the measurement compartment per the Appendix section.
4. Reboot the QwikCheck™QCe without a testing capillary in the chamber:
 - a. Turn system **OFF** then back **ON** at the main switch on the rear panel.
 - b. Press the front panel **ON/OFF** key to begin Auto-Calibration/Self-Test
5. Call for technical support if failure recurs.

Electronic Noise:

ELECTRONIC NOISE
TURN DEVICE OFF AND ON
IF SYSTEM FAILS AGAIN,
CALL TECHNICAL SUPPORT

- Follow steps 1-3 above.
- After cleaning:
 - Go to: **MAIN MENU > TEST NEW SAMPLE** and re-run the test.
- If this message is displayed again, reboot the QwikCheck™QCe :
 - Turn the system **OFF** then **ON** at the main switch on the rear panel.
 - Press the front panel **ON/OFF** key to begin Auto-Calibration and Stabilization.
 - From MAIN menu: Select **TEST NEW SAMPLE** and re-run.
- Call technical support if this message is displayed again.

If a testing capillary was left in the measurement chamber after testing a sample the following screen will be displayed before testing a new sample:

Remove Capillary:

REMOVE CAPILLARY
FOLLOW ON-SCREEN INSTRUCTIONS

Appendix I: EQUINE Semen Sample Preparation

EQUIPMENT REQUIRED:

- 10 ml Plastic Container provided in the QwikCheck Test Kit
- Pipette
- QwikCheck™ testing capillary
- QwikCheck™ on-board Heater (pre-set to 37C / 98.6F by manufacturer)

EXTENDED/COOLED SEMEN SAMPLES:

1. Place capillaries and 10 ml plastic containers in the heating unit
2. Mix the extended/cooled semen in its original package.
3. Transfer a 2 ml sample aliquot into the 10 ml plastic container.
4. Pre-heat the sample in the QwikCheck QCe on-board heater for **4 minutes for FROZEN and EXTENDED and 7 minutes for COOLED***
5. Pre-heat the testing capillaries in the QwikCheck QCe on-board heater for at least **4 minutes**
6. Gently and thoroughly mix the sample for 10 seconds
7. Fill a pre-heated QwikCheck testing capillary with extended semen following the Capillary Filling Instructions for EXTENDED and COOLED samples in the Appendix section.
8. Run a test following the instructions in this User Guide.

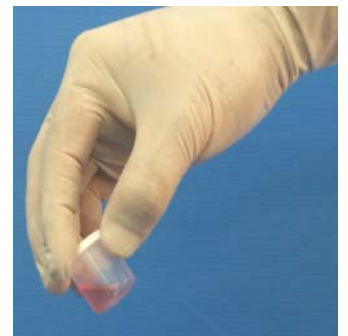
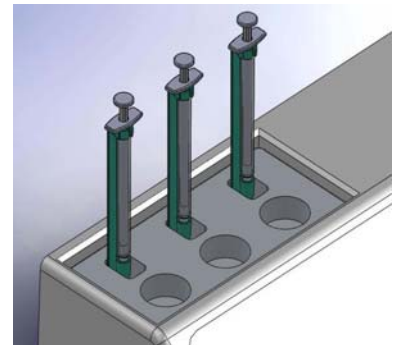

FROZEN SEMEN SAMPLES:

1. Thaw a frozen straw in a 37°C (98.6°F) water bath.
2. Expel the thawed sample (20 microliters required for testing) into a pre-heated 10-ml plastic container.
3. Heat the sample to 37°C / 98.6°F for 4 minutes.
4. Gently but thoroughly mix the sample.
5. The sample is now ready for testing.
6. Fill a pre-heated to 37°C / 98.6°F QwikCheck testing capillary with the semen sample following the instructions in the Appendix: Capillary Filling Instructions for FROZEN Samples.

WARNING: DO NOT FILL A TESTING CAPILLARY WITH SEMEN AND PLACE IN THE HEATER – IT WILL RUIN THE SAMPLE AND CAUSE SPILLAGE INTO THE HEATING SYSTEM

*Note

COOLED SAMPLES:

Pre Heating time for cooled samples is 7 minutes.

EXTENDED and FROZEN SAMPLES:

Pre Heating time for extended and frozen samples is 4 minutes.

Appendix II: Capillary Filling Instructions for EXTENDED and COOLED SAMPLES

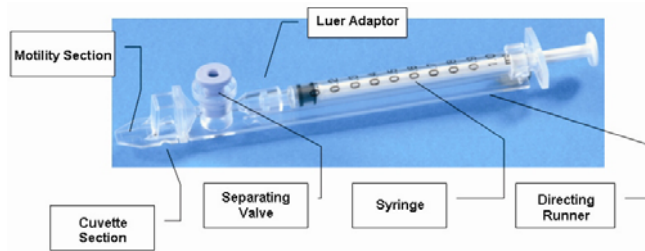

After heating the testing capillary AND separately heating the EXTENDED or COOLED semen sample:

1. Place the thin part of the testing capillary all the way into the 2ml of SEMEN. (Figure 1).
2. Aspirate the sample by pulling back on the plunger slowly. Keep the tip of the capillary well below the sample surface level. (Figure 1).
3. Draw up the sample (without air bubbles) until it appears in the syringe (Figure 2).
4. Check to see that the sample has completely filled the two sections of the capillary and there are NO AIR BUBBLES in the sample. (Figure 2).
5. Quickly wipe the top and bottom of the outer surface of the capillary with a tissue. (Figure 3).
6. Visually confirm that the capillary chambers are still full. If some of the sample has been lost, a meniscus will be visible in the thin section of the capillary. If sample has been lost, push very slightly on the piston to re-fill the thin capillary section.
7. Slowly and carefully push-in the BLUE separating valve until it is level with the plastic. (Figure 4)
8. The capillary is now ready for testing (Figure 5).
9. Insert the capillary into the QwikCheck QCe (Figure 5)



Figure 1



Figure 2



Figure 3



Figure 5



Figure 4

APPENDIX III: Capillary Filling Instructions for FROZEN SAMPLES

Sample size, collection container and preparation:

1. For testing FROZEN equine semen, a minimum of 20 microliters is required to fill just the thin "motility section" of a **pre-heated** testing capillary (Figure 1).
2. The semen sample must be **well mixed and free of bubbles prior to filling the testing capillary**. Gently rotate the container to fully mix the specimen. **WARNING:** Do not shake nor use a pipette to aspirate and dispense specimen in order to mix, otherwise air bubbles will form.

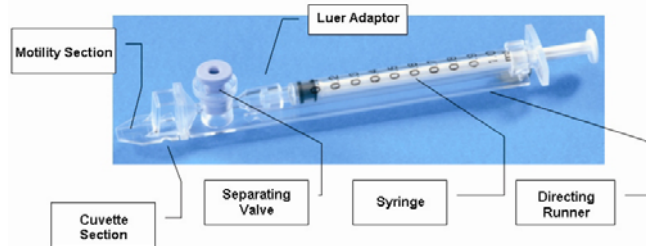

Figure 1

Filling the capillary:

1. **Push the syringe piston in all the way.** Place only the thin part of the capillary into the bottom of the sample.
2. **Pull the piston back slowly**, while keeping the capillary in the sample (figure 2).
3. **Fill only the (thin) motility chamber** with 20 micro liters of **pre-heated** semen.
4. Continue to pull back on the piston until some of the sample is seen in the square cuvette part of the testing capillary.
5. Look at the testing capillary, make sure that the sample has completely filled the thin section and there is no meniscus (Figure 3).
6. **Quickly and thoroughly wipe the outer surface of the capillary** - It is important to remove all semen from the exterior of the capillary in order to prevent the QwikCheck QCe from becoming clogged (Figure 4).
7. After cleaning, look to see that the thin chamber of the capillary is still full of semen (Figure 3).
8. If some of the sample is missing push-in the piston slightly until a drop appears on the capillary tip and then fill the capillary again from the sample container.

Removing the blue valve:

Remove the blue valve before inserting the capillary into the QwikCheck QCe using a black (white shown) capillary jig to displace the valve (Figure 5).

PLEASE NOTE: Test FROZEN samples as soon as the blue valve is removed!



Figure 2



Figure 3



Figure 4



Figure 5

Appendix IV: Capillary Washing/Drying Instructions (For animal applications ONLY)

Washing the QwikCheck QCe Testing Capillary



Reposition the blue valve with the jig

Capillary Washing Instructions

Veterinary testing capillaries and 10ml sample collection cups can be washed and re-used up to 10 times. Follow this EASY procedure for all 10 cycles of washing.

Washing Instructions:

Step 1 After running a test:

- Use the white capillary jig to re-position the blue capillary valve
- Expel semen by pumping the plunger a couple of times
- Soak the testing capillary in tap water until ready to wash

Step 2 Set-up: Fill with 1 liter/2 quarts of solution as follows:

- Bowl #1: Tap water (marked "TAP WATER")
- Bowl #2: Distilled water (marked "DISTILLED WATER")
- Bowl #3: Isopropyl Alcohol 70% - 100%

Step 3: Expel all liquid from the testing capillary:

- Pump the syringe plunger a couple of times to expel all remaining liquids.

Step 4: Capillary Washing – Follow this order:

- **Bowl #1 Tap Water:** Completely fill each capillary with tap water. Expel the solution into a hazardous waste container. **Repeat 2 times** then go to Bowl 2.
- **Bowl #2 Distilled Water:** Completely fill each capillary with distilled water. Expel the solution into a hazardous waste container. **Repeat 2 times** then go to Bowl 3.
- **Bowl #3 Isopropyl Alcohol:** Completely fill each capillary with isopropyl alcohol and expel the solution into a hazardous waste container. **Repeat 2 times.**
- After the final washing: Completely remove the plunger from the syringe.



After final washing – remove the plunger of the syringe for drying

Step 5: Drying the Capillaries:

- Place the capillaries on a flat surface and dry overnight or place in a low heat oven for a few hours until they are completely dry.

Step 6: Final Preparation/Inspection:

- Replace the plunger into the syringe.
- Inspect the capillary and throw away if cracked, broken or semen remains.
- Note the number of washings by making a dot on the capillary with a water proof marker after each washing cycle.



Reassemble the capillary

Washing the 10 ml sample collection cups

Washing – Please refer to Step 4 Capillary Washing and follow the same process for washing in the solutions in bowls #1; #2 and #3. Turn upside down on absorbent paper to dry overnight.

Capillary Drying Instructions

A simple desiccator can be made to dry testing capillaries using the silica gel beads provided in the QwikCheck™QCe start-up kit.

Drying the QwikCheck QCe Testing Capillary

Materials/Equipment Required:

- 1 kg of the blue Silica gel beads
- 1 large airtight plastic box/jar container.
- Plastic netting
- 50 washed capillaries

Drying Instructions:

Step 1: Assemble the desiccator

- Pour all of the Silica gel beads into the desiccation container.
- Put plastic net over the silica beads.
- Place 50 washed capillaries on the net.

Step 2: Close the desiccator

- Tightly close the cover of the desiccator.

Step 3: Capillary Drying

- After 12-24 hours, see if the capillaries are dry (without opening the cover!).
- If the capillaries appear dry, open the desiccator and check closely to see if all of the water has evaporated from the capillaries.
- If they are still wet, close the desiccator and check again in 2 hours.
- Remove the capillaries and tightly close the desiccator to preserve the beads.

Step 4: Capillary re-assembly:

- Slide the plunger back into the syringe.
- Inspect the capillary for cracks, broken parts or remaining semen.
- Discard capillaries that are damaged or contaminated.
- Mark the capillary with a dot after each washing-drying cycle.
- The capillaries are ready for use.

Step 5: Silica gel re-activation:

When the BLUE silica gel beads turn PURPLE/PINK they need to be dried:

- Heat for 3 to 4 hours @ 130°C
- Periodically mix the beads during the drying cycle.
- When the color of the beads turns BLUE, place them in the desiccator and close tightly.



Silica gel beads



Capillaries drying
on plastic net
above silica beads

APPENDIX V: Cleaning the QwikCheck QCe Testing Chamber

When to clean:

Daily or after every 25 tests
If the system fails **SELF-TEST**

Cleaning kit components:

- Blue Dot capillaries (Fig. 1)
- Sponge-tipped drying capillaries (Fig. 2)
- Cleaning brush -wooden-handled (Fig. 4)
- Cleaning fluid

CLEANING: STEP 1

1. **TURN OFF** the QwikCheck QCe.
2. Use a **BLUE DOT** fibrous material capillary (Fig. 1).
3. Moisten with ONE drop of cleaning fluid, shaking off excess fluid.
4. Insert into the measurement compartment - fibrous material facing up. Move back and forth a few times. Repeat with the material facing down.
5. Use a sponge-tipped drying capillary to dry the same compartment (Fig. 2-3).

CLEANING: STEP II

1. Insert the brush (bristle-side down – Fig. 4) into the measurement chamber of the QwikCheck QCe (Fig. 5).
2. Pull the brush out of the chamber while sweeping or "dusting off" the lens (you will feel a step or shelf at the back and top of the chamber – this is the top of the lens).
3. Switch QwikCheck QCe system ON and observe Self-Test results. The analyzer should now PASS the Self-Test. If not, repeat cleaning procedure with the brush.

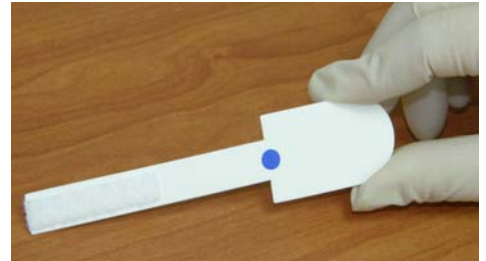

Figure 1

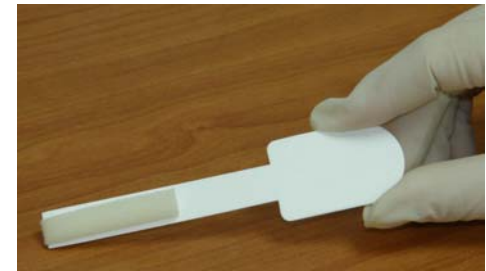

Figure 2



Figure 3



Figure 4



Figure 5

Appendix VI: Glossary of QwikCheck™ QCe Terms

	Parameter	QwikCheck™ QCe Terms	Definition
Sample Data	Serial number	SN	Serial Number of the SQA-Ve
	Date & time	DATE/TIME	The date and time the test was performed
	Stallion ID	STALLION ID	The identifying number of the stallion being tested
	Straw date	STRAW DATE	The date and time the frozen semen straw was produced
	Sample number	SAMPLE #	The number assigned to the semen sample
	Semen volume	SEMEN VOLUME	Extended, cooled or frozen semen volume expressed in ml
Test Results	Motile Sperm Concentration	MSC	Motile sperm concentration expressed in millions/ml
	Motility	MOTILITY	The ratio between the motile and total sperm cells in the sample, expressed in %.
	Progressive Motility	PROG. MOT.	The ratio between the progressively motile and total sperm cells in the sample, expressed in %.
	Average velocity	VELOC.	The average velocity of the motile spermatozoa in the sample, in microns per second.

Appendix VII: System Specifications

Dimensions: 14 X 34.5 X 21 cm (HxWxD)

Weight: 3.5 kg

AC power supply: 100 to 250 VAC, 50/60 Hz, 10 VA

Measurement Compartment

- **Sources of radiant energy** - two 880 nm LEDs for motility and spectrophotometry channels
- **Detector system** – 2 photo detectors - Motility and Optical Density

Display(s)

- Operational backlight LCD (16 lines x 40 characters)

Keypad

- **Operational keys:** ON/OFF, TEST, PRINT, SERVICE, DELETE, ENTER, four cursor buttons, ESC, numeric buttons (0-9)

Front Panel

- LCD operational display
- Measurement compartment
- Multi-button keypad

Rear/Side Panel

- Power connector with fuse-holder (fuse 250V, 1A)
- RS232 cable outlet
- I-Button port (side panel)

Specimen Testing Supplies

- **Measurement capillary:** Disposable, multi-use plastic. (purchase from manufacturer).
- **I-Button:** Required to run tests (purchase from manufacturer)

Archive Capacity

- None

Operating System

- **Control:** Keypad
- **Analysis Time:** 45 seconds (2 minute pre-heating)
- **Software:** Resides on flash memory and drives all man-machine interface functions, runs algorithms for test measurements and operational screens. System can be upgraded from a PC CD-ROM.
- **Sample Testing Temperature:** 37⁰C (98.6⁰F).
- **Motility channel input signal:** Analog, up to 5V.
- **Spectrophotometer channel input signal:** Modulated (1 kHz) analog, up to 5V.

Quality Control

- **Internal:** Electronic Self-Test and Auto-Calibration.

Operational Temperature and Humidity

- System is operational at 20-30°C.
- NOTE: QwikCheck™QCe is calibrated to measure semen samples heated to 370C (98.60F).
- System is fully operational at up to 80% humidity.



Maintenance Schedule

- Cleaning daily and after every 25 tests (refer to User Guide – "Cleaning Instructions").

Manufacturer Recommendations

- Operate the QwikCheck™QCe away from devices that may cause electronic noise (cell phones) or other devices causing vibrations such as centrifuges.
- Turn system **OFF** at the rear-panel when not in use for extended period of time.
- Semen is considered a biologically hazardous material and is subject to individual laboratory protocols for handling such materials.

Factory Default Settings:

Date format: DD/MM/YY

Time/Date: Manufacturer's local time/date

Sample Type: EXTENDED

Automatically print: YES

Labels to Print: 1

Extender transparent?: YES

